

DISTRIBUTOR/AGENT:	DATE OF ORDER:
	DATE OF DELIVERY:
	NAME OF THE ADDRESSEE/USER:



ISO 7176/19 and ANSI RESNA WC/19



very breathable and fire retardant upholstery



Marked

FEATURES

- **Adjustable Trolli** is available in three sizes:
- **Frame:** light and umbrella folding system, in aluminium. It is painted with non-toxic epoxy powders. When folded Adjustable Trolli is compact and it allows you to carry it as if it was a travel trolley.
- **Available in two versions:** with backrest extension or with multiadjustable headrest, both foldable with frame.
- **Push handles with manual and parking brakes.**
- Resistant and durable **Backrest** guaranteed by the cross on the back. Reclinable on three positions and easily adjustable in height.
- Slightly tilted **Seat.** It is adjustable in depth and width thanks to padded pelvic side supports (additional components 958). The cross below ensures stability, comfort and durability.
- Extremely breathable **Upholstery** (not removable). It is resistant and easily washable. **Fire Retardant** according to *EN 1021-1:2014 and EN 1021-2:2014.*
- User manual **Bag** and wrench on the back of the backrest.
- **Legrest** adjustable in height. Elevatable and swivel **Footrests**, without encumbrance.
- **Front solid swiveling Wheels** 17 cm (7 in) for size 36 and 40; 20 cm (8 in) for size 43.
- **Rear solid Wheels** with **independent drum brakes**, 25 cm (10 in). for size 36 and 40; 30 cm (12 in) for size 43. **Overcoming step bar** on both wheels.

Please check off the interested products



Attention! Read carefully the user and maintenance manual

MEASURES

- Size: size 36 size 40 size 43
- Upholstery colour: Red Black
- Frame colour: **Black**

Unit of Measurement: cm (in)

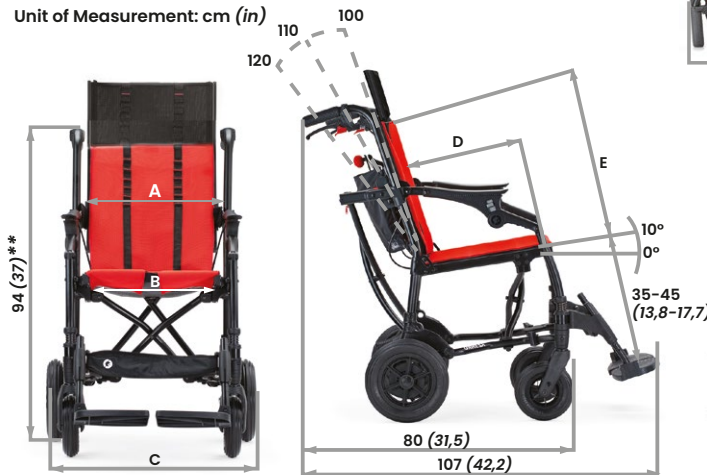

closed with MULTIADJUSTABLE HEADREST 863

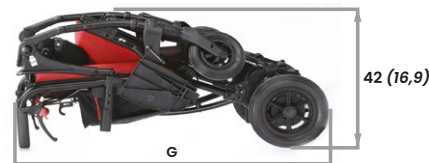

with 956: kit self propelling wheels



closed with BACKREST EXTENSION 823

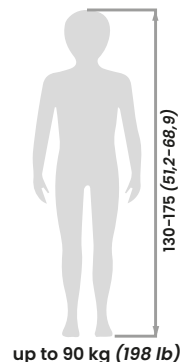

up to 90 kg (198 lb)

	A	B	C	C1	D	E	F	G	Tot. weight
size 36	39 (15,4)	36 - 32 - 28 * (14,2 - 12,6 - 11 *)	59 (23,2)	64 (25,2)	36-46 (14,2-18,1)	46-56 (18,1-22)	42 (16,5)	94 (37)	15,1 kg (33,2lb)
size 40	43 (16,9)	40 - 36 - 32 * (15,7 - 14,2 - 12,6 *)	63 (24,8)	68 (26,8)	36-46 (14,2-18,1)	46-56 (18,1-22)	46 (18,1)	94 (37)	16,1 kg (35,4lb)
size 43	46 (18,1)	43 - 39 - 35 * (16,9 - 15,4 - 13,8 *)	66 (26)	71 (27,9)	36-46 (14,2-18,1)	46-56 (18,1-22)	46 (16,5)	97 (38,1)	17,1 kg (37,6lb)

* Using the 958 padded pelvic side supports the width is reduced by 4 cm (1,6 in) or 8 cm (3,2 in) removing the internal padding. 36-40-43 cm (14,2-15,7-16,9 in) width without padded pelvic side supports.

** Height adjustment range with add-on 951 max. 101 cm (39,7 in)

COMPONENTS

951 Height adjustable push handles. Tools Free!
COMPONENT TO BE ORDERED WITH THE PRODUCT.



NEW

↙ **TO BE COMPLETED WITH:**

823 Backrest extension with slots for 865 and 835. Folds down for transport.



NEW

863 Multiadjustable headrest in height, tilt and depth.



If any option is selected, the 823 backrest extension will be provided.

↙ **COMPONENTS TO CHOOSE ALSO AFTERSWARDS**

Only with backrest extension 823

865 Padded, breathable headrest, height adjustable.
 S-M



NEW

835 Shaped and enveloping headrest, height adjustable.
 S-M



NEW

838 Trunk side supports adjustable in height, width, inclination and rotation.
 S M

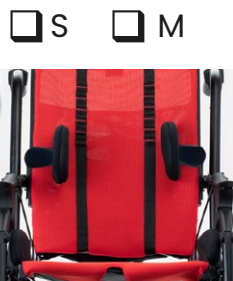

868 Wrappable and flexible trunk support, multiadjustable in height, width and inclination.
 mini S/M
Only for size 36

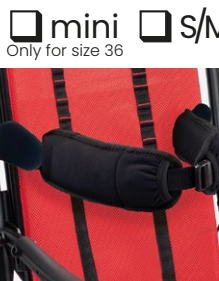

958 Padded pelvic side supports they reduce the seat width by 4 cm (1,6 in).
 Extra Padding they reduce the seat width by 8 cm (3,2 in).

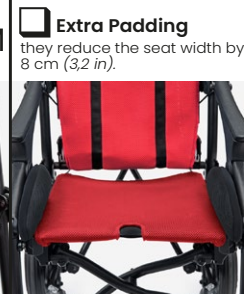

947 Pelvic belt with variable angle
 S M

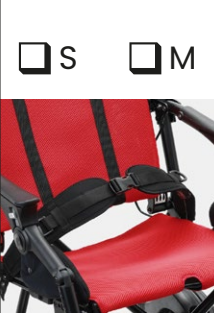

920 4 point pelvic belt
 S M

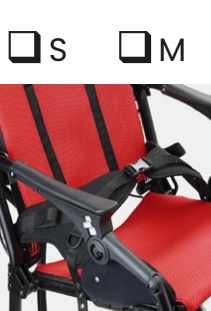

853 slim 4 point shaped harness
 M

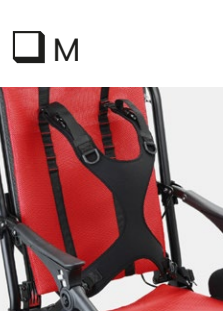

853 Vest harness
 S

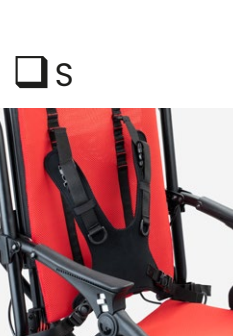

834N Padded and removable abduction block
 mini/S M

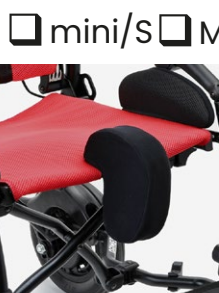

839 Front handlebar, adjustable in tilt

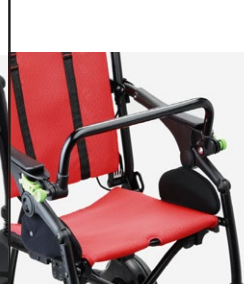

960 Heel rests



956 Footrests adjustable in tilt



858 Shopping basket



Only for sizes 36 and 40 with backrest extension 823

819 Elevating Canopy with bag. Foldable with the frame
NEW



825 Rain cover to fix on the 819 canopy
NEW



825B Back protection cloth to fix on the 819 canopy
NEW



968 Padded covers for armrests easy to remove for washing.
NEW



812 Front wheel direction locks



844 Padded side protection covers



891 Set of 4 tie down hooks for the forward-facing transport of the pushchair in a motor vehicle.
CRASH TESTED
ISO 7176/19 and ANSI RESNA WC/19



966 Kit self propelling wheels (22") with drum brakes, anti-tip device and quick release. For size 43, also the front wheels are provided. The additional component padded pelvic side support (958) can't be fixed.
NEW



COMPONENTS MEASURES

863

Size 36 > A= 15 cm/5,9 in
 Size 40 > A= 15 cm/5,9 in
 Size 43 > A= 19 cm/7,4 in
 Size 36-40-43 > B= 19-25 cm/7,4-9,8 in

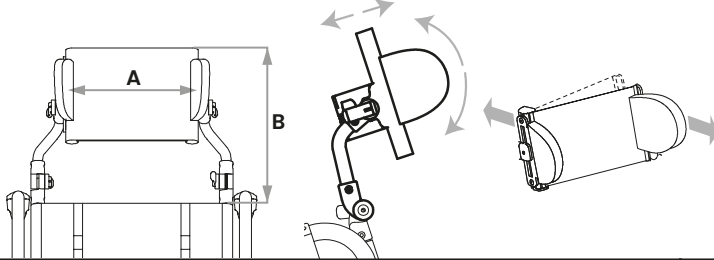

823

Size 36 > A= 36 cm/14,2 in B= 20 cm/7,87 in C= 15,8 cm/6,2 in
 Size 40 > A= 40 cm/15,7 in B= 20 cm/7,87 in C= 15,8 cm/6,2 in
 Size 43 > A= 43 cm/16,9 in B= 20 cm/7,87 in C= 15,8 cm/6,2 in
 Size 36-40-43 > B= 20 cm/7,87 in

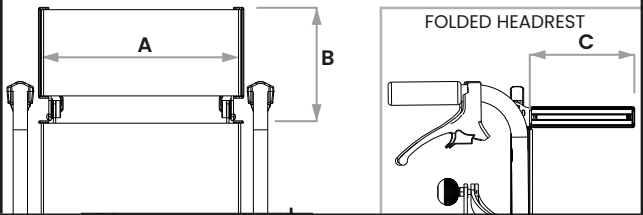

838

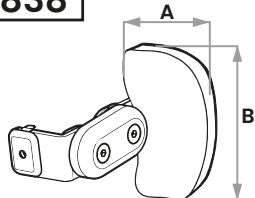

Size 36 > C= 14-23 cm/5,5-9 in
 Size 40 > C= 20-29 cm/7,87-11,4 in
 Size 43 > C= 22-31 cm/8,66-12,2 in

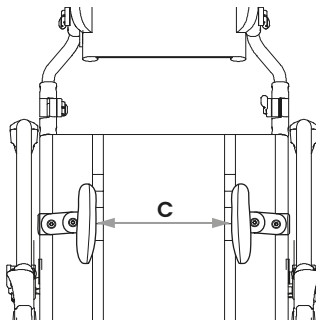

small
 A=10 cm/3,9 in
 B=12 cm/4,7 in
 medium
 A=11 cm/4,3 in
 B=17 cm/6,6 in

947



small
 A=19 cm/7,4 in
 B=6 cm/2,3 in
 medium
 A=25,5 cm/10 in
 B=8 cm/3,1 in

920

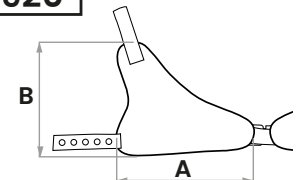

small
 A=16 cm/6,2 in
 B=15,5 cm/6,1 in
 medium
 A=23 cm/9 in
 B=19 cm/7,4 in

853 slim

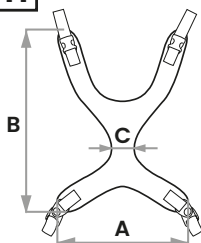

medium
 A=33 cm/12,9 in
 B=46 cm/18,1 in
 C=5 cm/1,9 in

834N

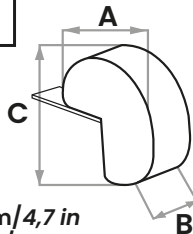

mini/S
 A=12 cm/4,7 in
 B=4 cm/1,5 in
 C=14 cm/5,5 in
 medium
 A=15 cm/5,9 in
 B=4 cm/1,5 in
 C=17 cm/6,6 in

868

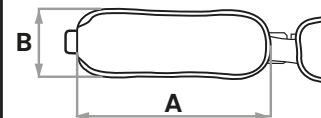

mini
 A=23 cm/9 in
 B=9 cm/3,5 in
 S/M
 A=26 cm/10,2 in
 B=9 cm/3,5 in

853

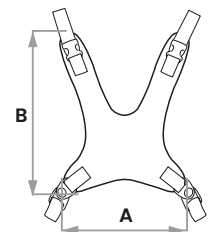

small
 A=25 cm/9,8 in
 B=34 cm/13,3 in

951

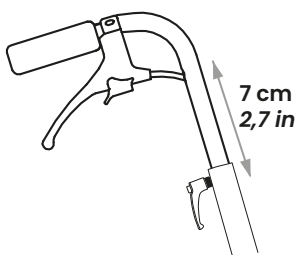

Notes.....

